

ANTENNA OPTIMIZATION FOR SHEAR ALFVÉN WAVE RESONANCE HEATING

D. Kortbawi
F.D. Witherspoon
X.Y. Zhu
T. Casavant
S.C. Prager
J.C. Sprott

PLP 934

October 1984

Plasma Studies

University of Wisconsin

These PLP Reports are informal and preliminary and as such may contain errors not yet eliminated. They are for private circulation only and are not to be further transmitted without consent of the authors and major professor.

ABSTRACT

Antenna Optimization for Shear Alfvén Wave Resonance Heating.* D. KORTBAWI, F.D. WITHERSPOON[‡], S.Y. ZHU, T. CASAVANT, S.C. PRAGER, and J.C. SPOTT, University of Wisconsin-Madison--Using a second generation of antenna on Tokapole II it has been found that the radiation resistance varies from a maximum of 0.5Ω when the antenna is oriented so as to generate a \vec{B} approximately perpendicular to the equilibrium field to a minimum of 0.18Ω at the extreme of rotation ($r_{vac}=0.10\Omega$). The measured internal rf resonant magnetic field (\vec{B}) however is roughly independent of the antenna orientation thus indicating that the loading is at least partly parasitic.

These results have motivated the design of a third generation of antenna which will be fully rotatable thus allowing launching of waves of any polarization to optimize coupling to the shear Alfvén wave.

Direct observation of the wave field by magnetic probes has produced results with a resonant spatial structure and polarization consistent with the shear Alfvén resonance.

The RF diagnostic system is being upgraded and a 1 MW source and charge exchange analyzer are being installed.

[‡]GT-Devices.

*This work is supported by the U.S.D.O.E.

TOKAPOLE II PARAMETERS

- FOUR NODE POLYIDAL DIVERTOR
- MICROWAVE PREIONIZATION
- MAJOR RADIUS 50 cm
- MINOR RADIUS 6-10 cm
- TOROIDAL FIELD 4.5 kG
- PLASMA CURRENT ~30 kA
- LINE AVERAGED DENSITY $5 \times 10^{12} \text{ cm}^{-3}$
- ELECTRON TEMPERATURE ~100 eV
- ION TEMPERATURE ~20 eV
- DISCHARGE LENGTH ~3-10 msec
- BASE VACUUM ² $6 \times 10^{-7} \text{ Torr}$

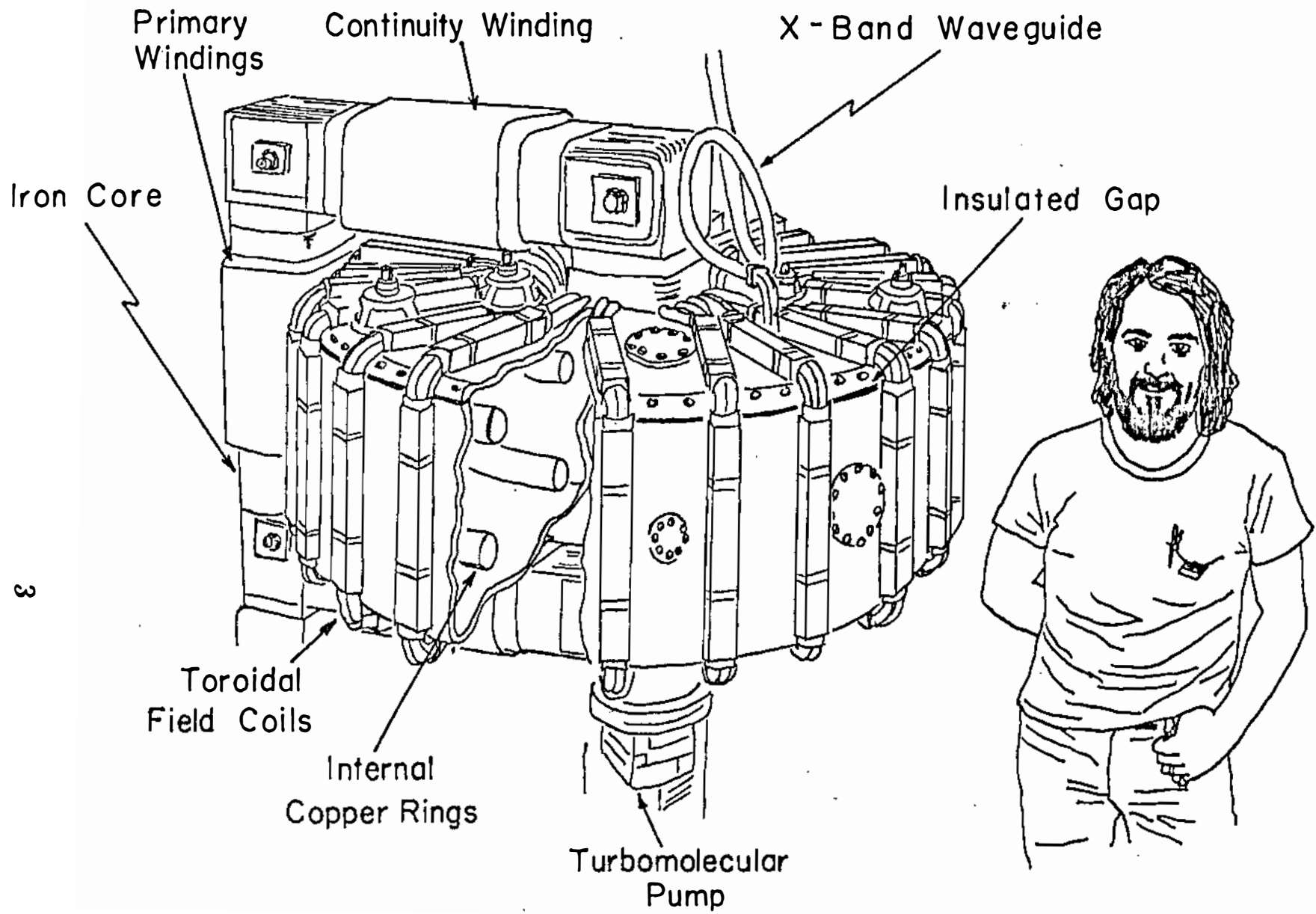

TOKAPOLE II

TWO ANTENNAS OF THIS DESIGN ARE PRESENTLY IN USE.

Maximum rotation $\pm 45^\circ$
wrt the toroidal axis

Radial insertion range 6cm

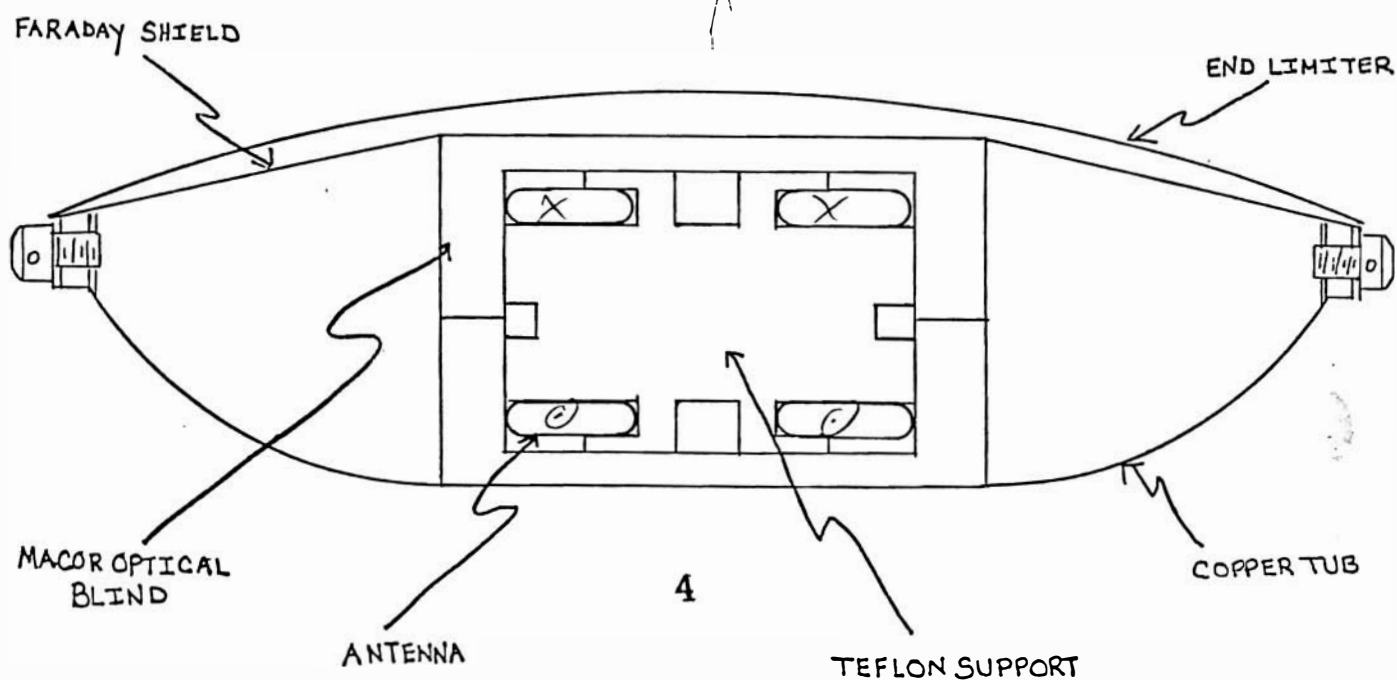

TWO ANTENNAS OF THIS NEW DESIGN ARE UNDER CONSTRUCTION.

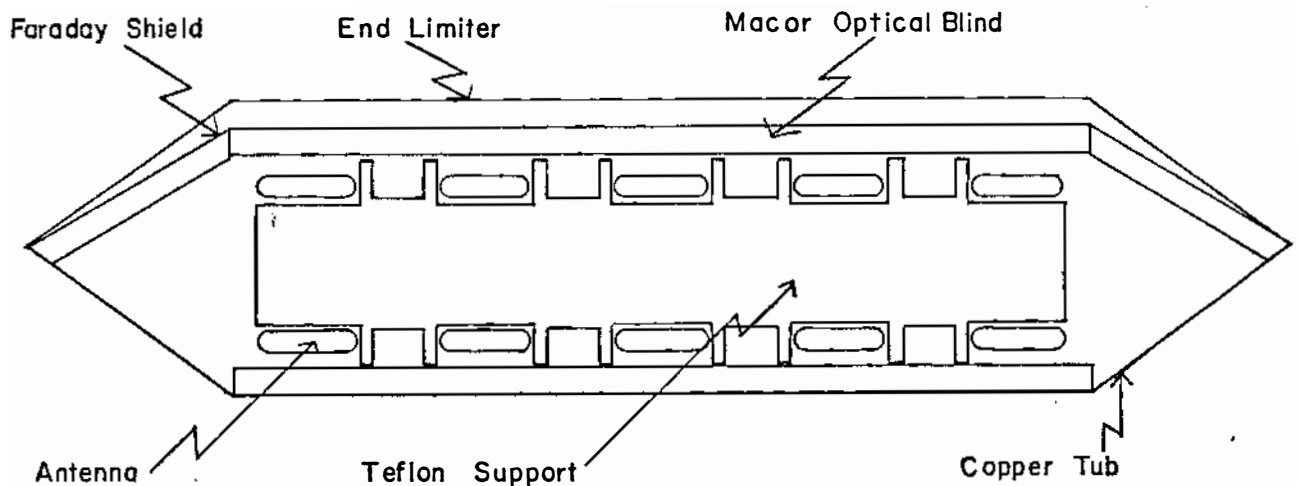

A new antenna has been designed which will rotate a full 360° . This will allow launching of waves of any polarization and investigation of possible mode conversion processes. It will also have a removable Faraday shield.

TOKAPOLE II SHOWING LOCATION OF ALFVEN WAVE ANTENNAS

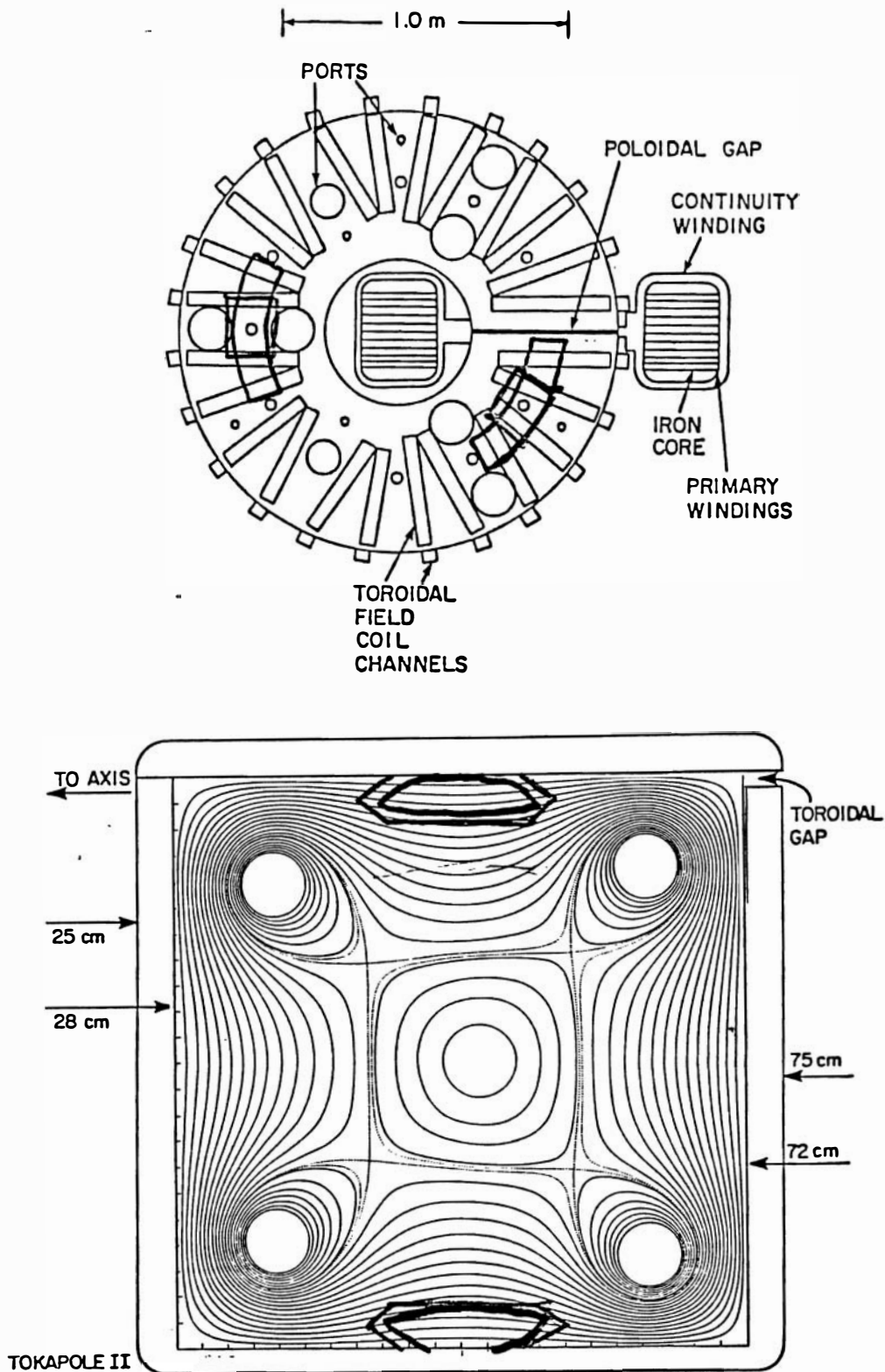

**FOUR ANTENNAS
WILL BE USED.**

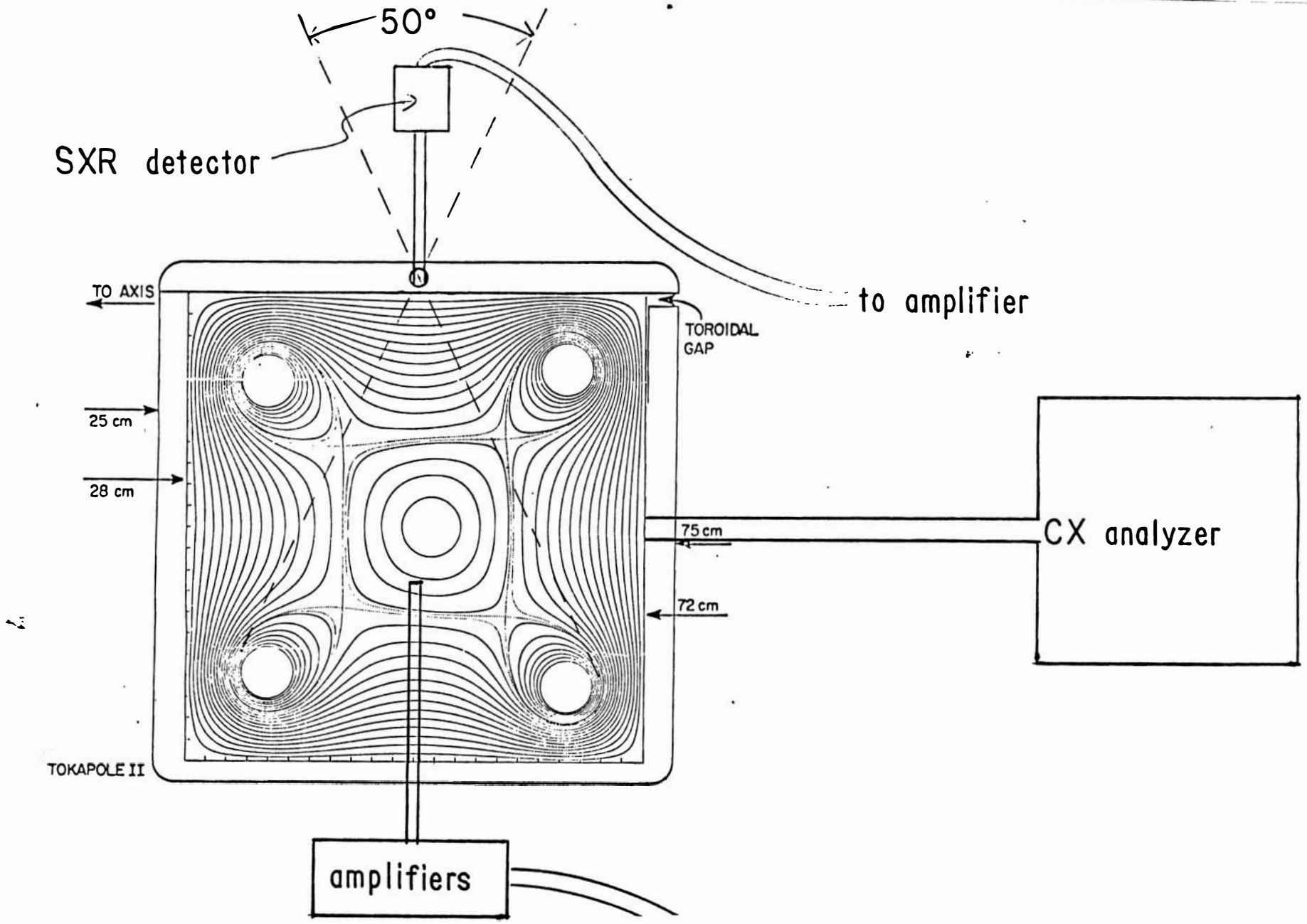

Diagnostics include magnetic probes,
 SXR detectors and charge exchange
 analysis.

to electronics

Magnetic probe signal will be detected, processed and digitized.

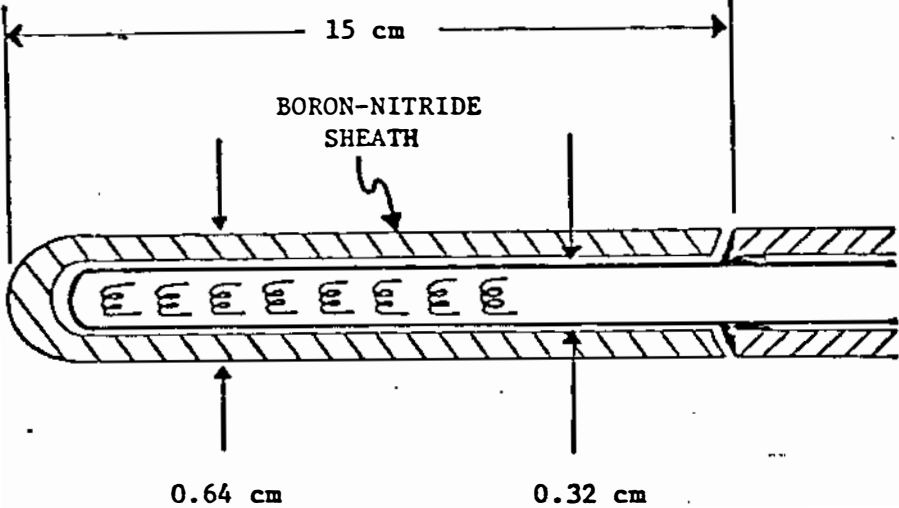

Wall thickness 0.025 cm

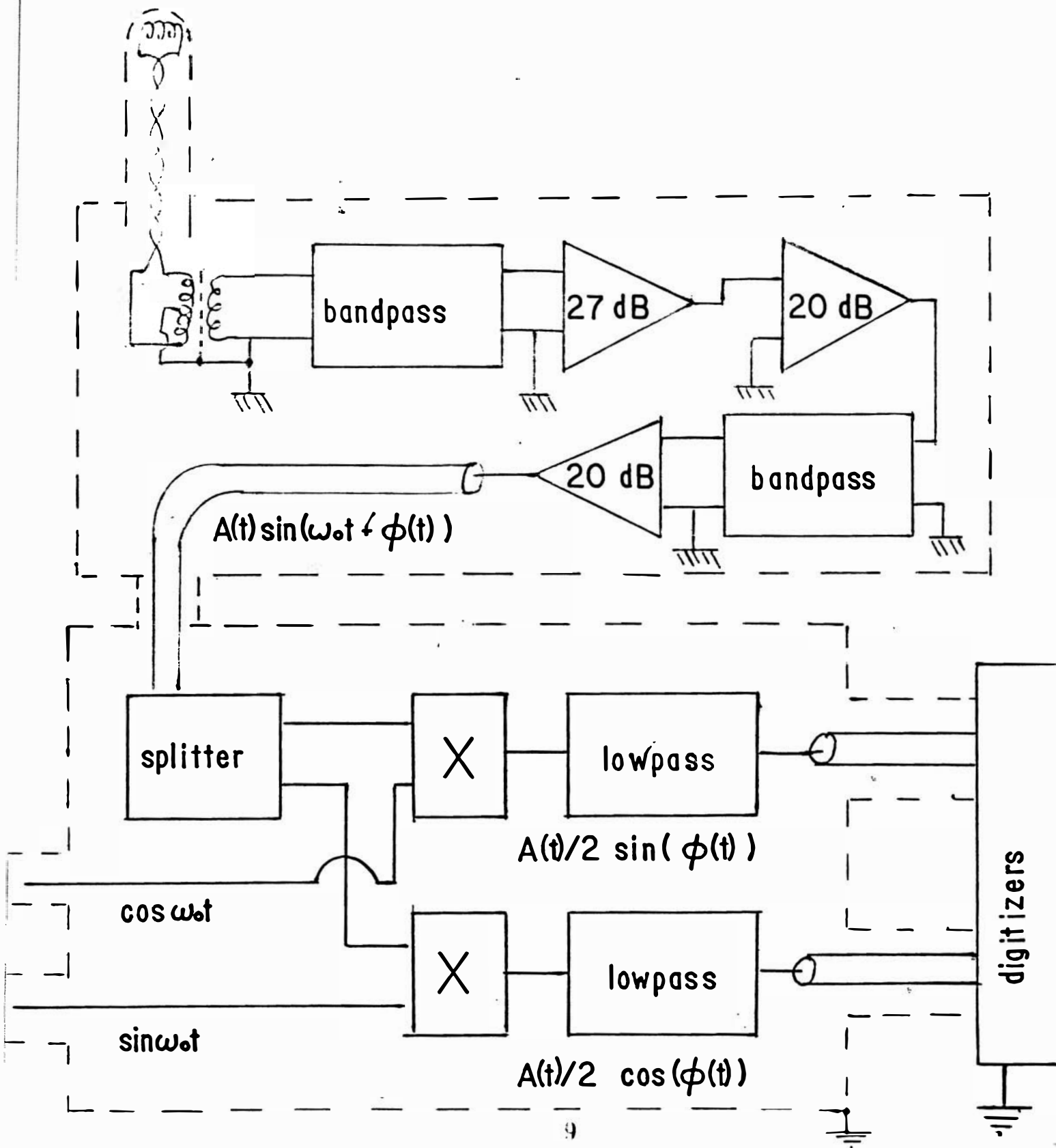

GETTERING HELPS MINIMIZE IMPURITY GENERATION.

RADIATED LIGHT #27040 10-OCT-84

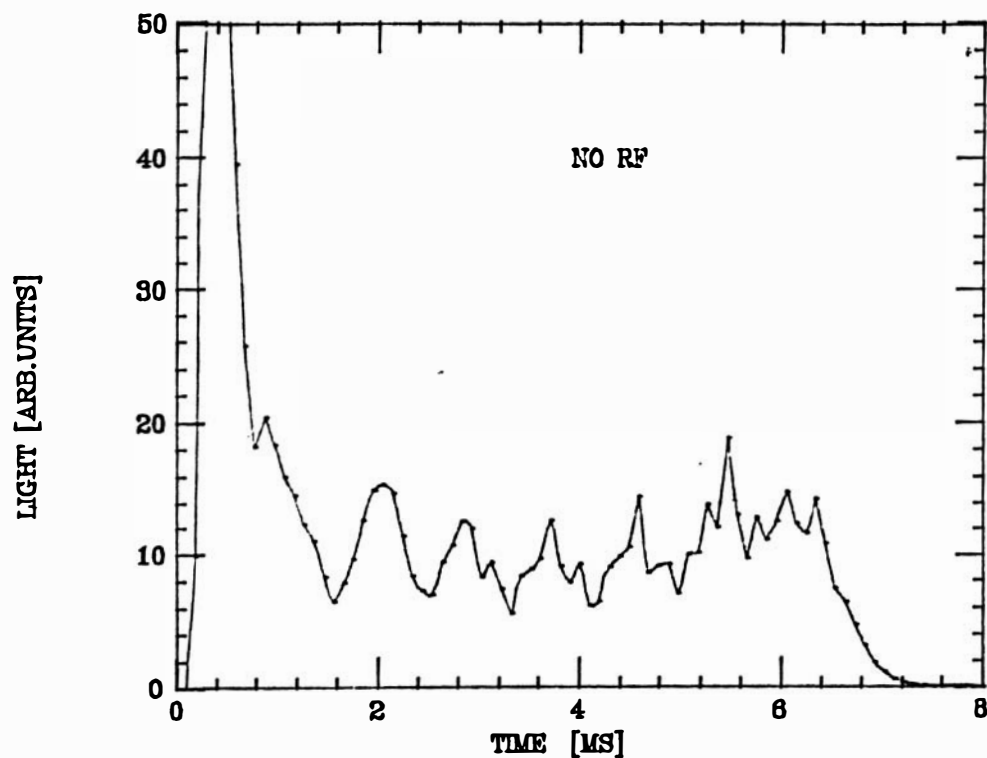

no RF

RADIATED LIGHT #27043 10-OCT-84

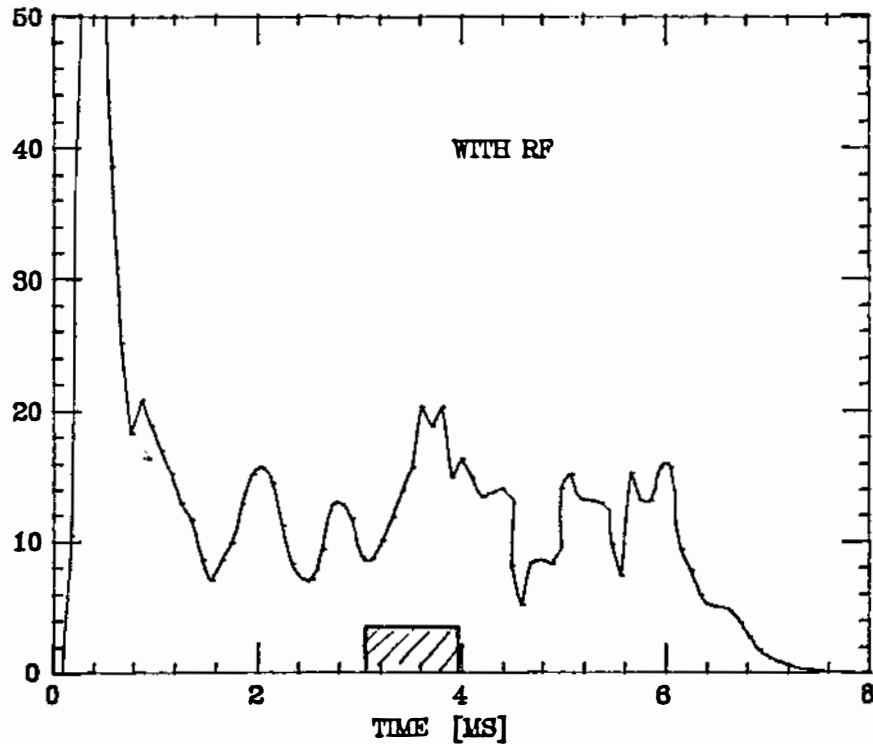

with RF shortly after gettinging

RADIATED LIGHT #27065 10-OCT-84

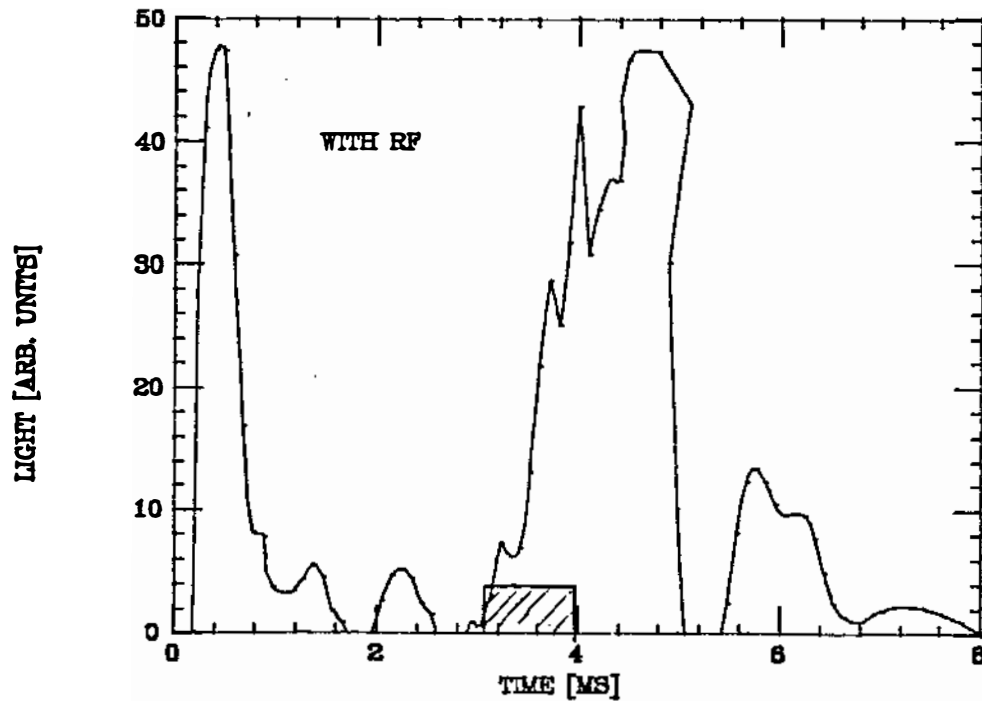

with RF long after gettinging

SXR EMISSIVITY PROFILES INDICATE SURFACE HEATING.

TOP SXR SCAN AT T= 2.3 MS

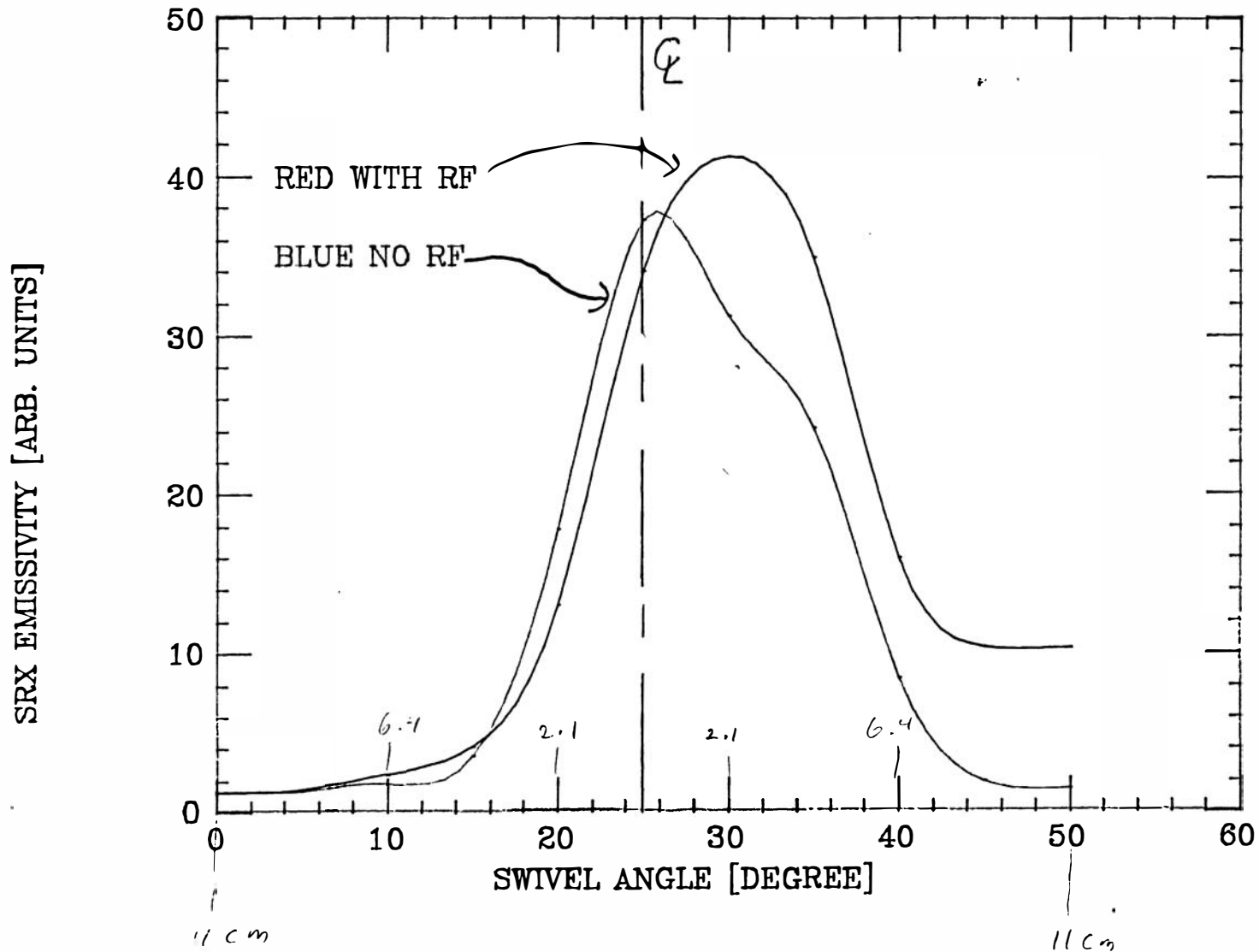

Discharge moves outward with RF.

RF on at 2.0 msec

TOP SXR SCAN AT T= 2.1 MS

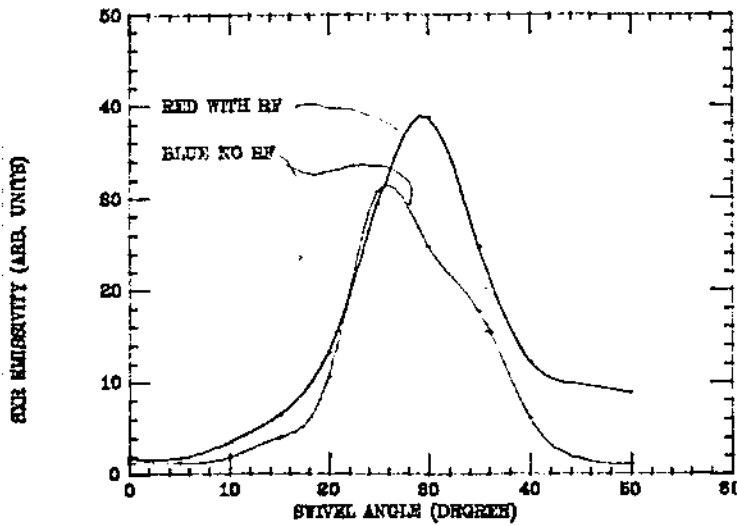

TOP SXR SCAN AT T= 2.7 MS

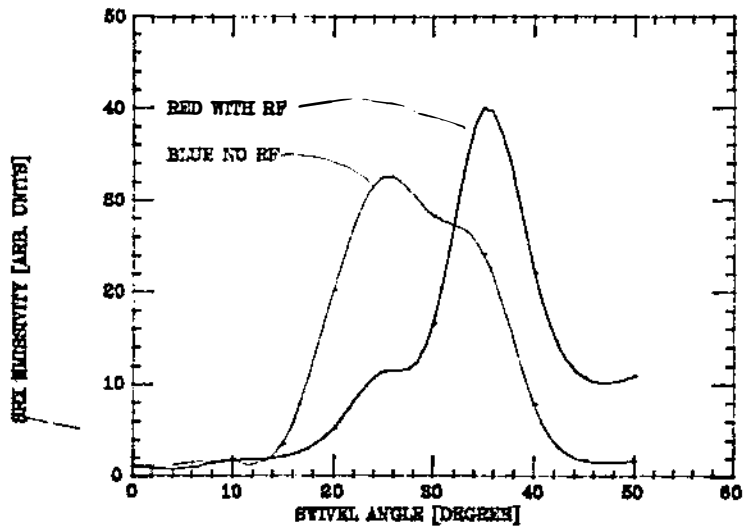

TOP SXR SCAN AT T= 2.2 MS

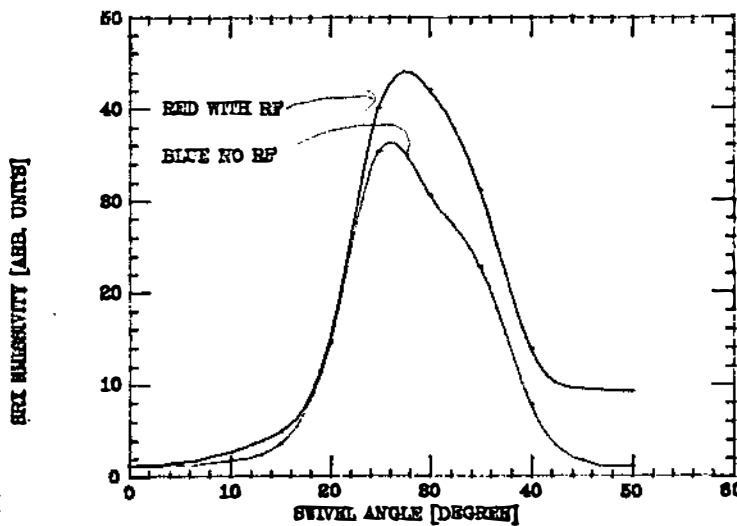

TOP SXR SCAN AT T= 2.8 MS

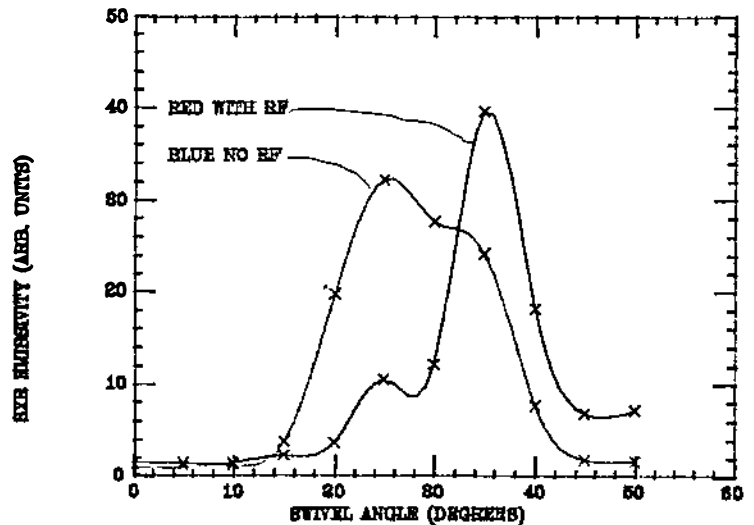

TOP SXR SCAN AT T= 2.3 MS

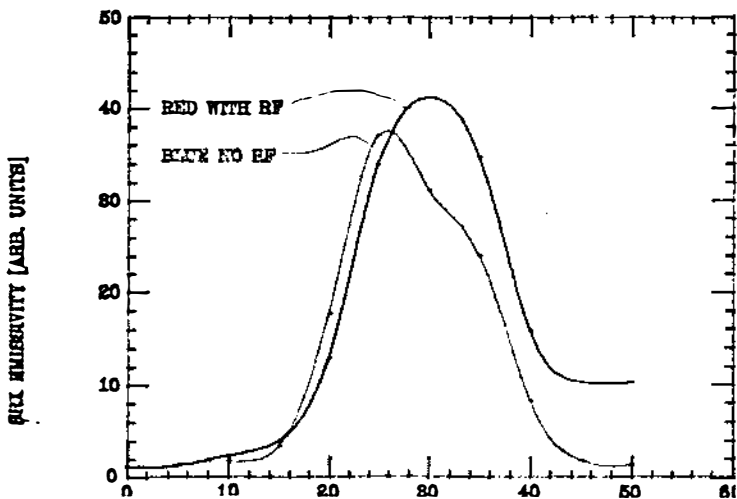

TOP SXR SCAN AT T= 2.9 MS

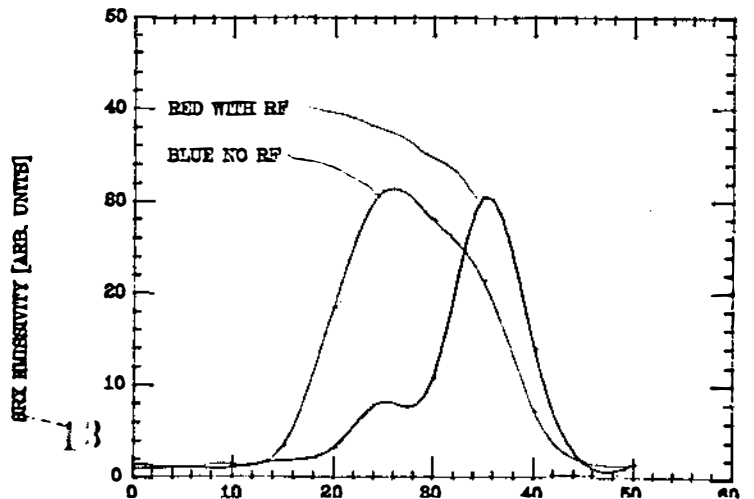

TOP SXR SCAN AT T= 2.4 MS

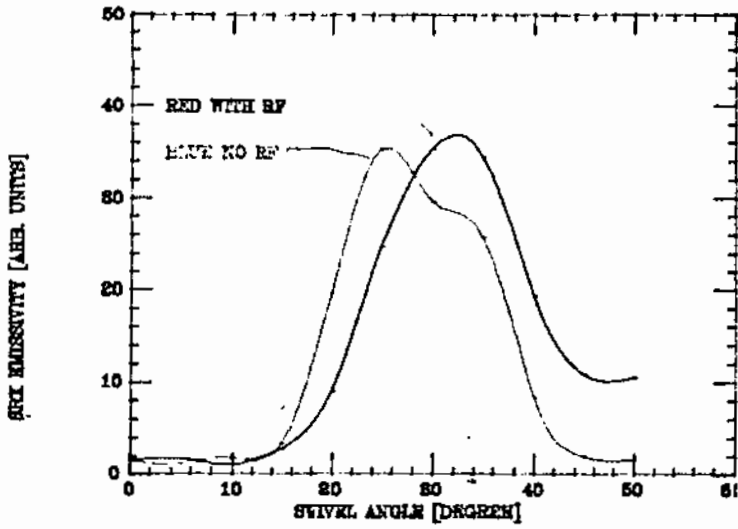

TOP SXR SCAN AT T= 3.0 MS

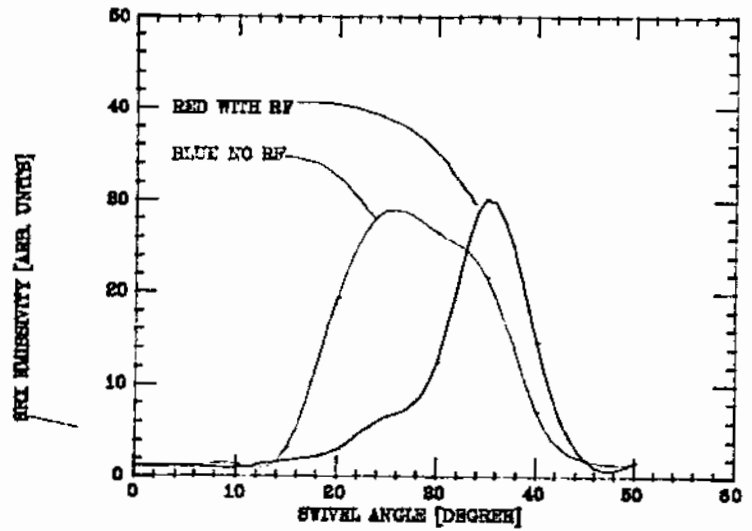

TOP SXR SCAN AT T= 2.5 MS

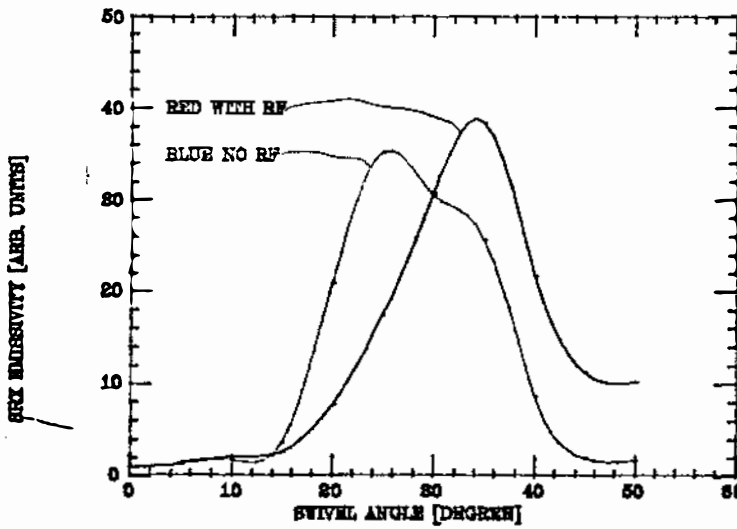

TOP SXR SCAN AT T= 3.1 MS

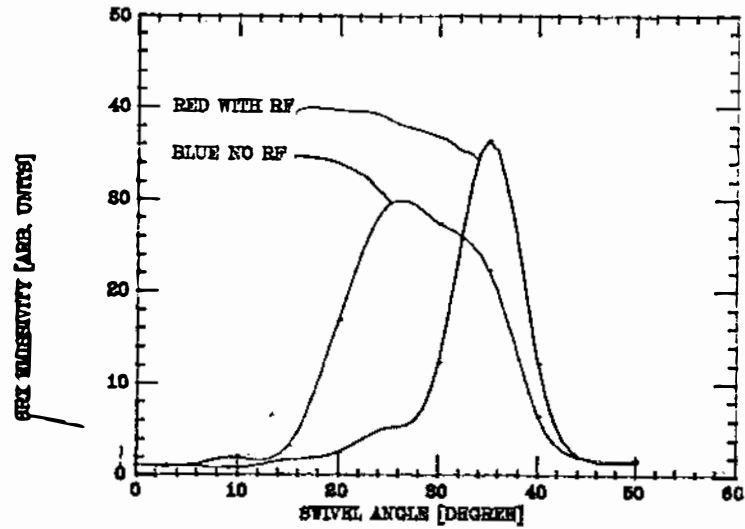

TOP SXR SCAN AT T= 2.6 MS

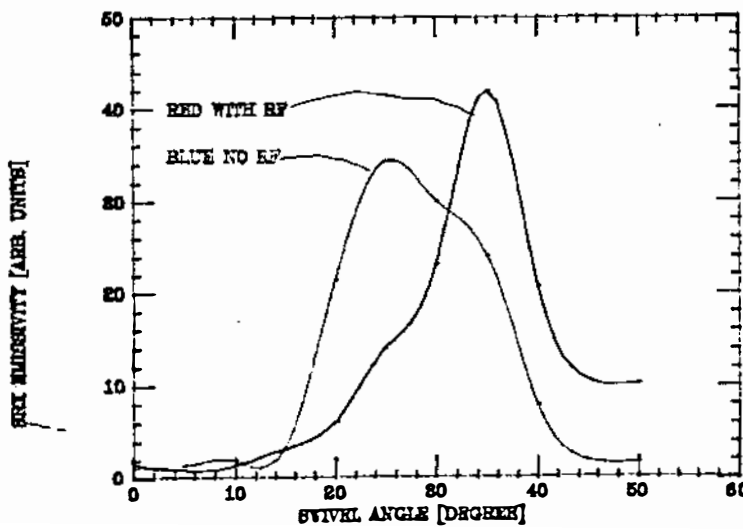

TOP SXR SCAN AT T= 3.2 MS

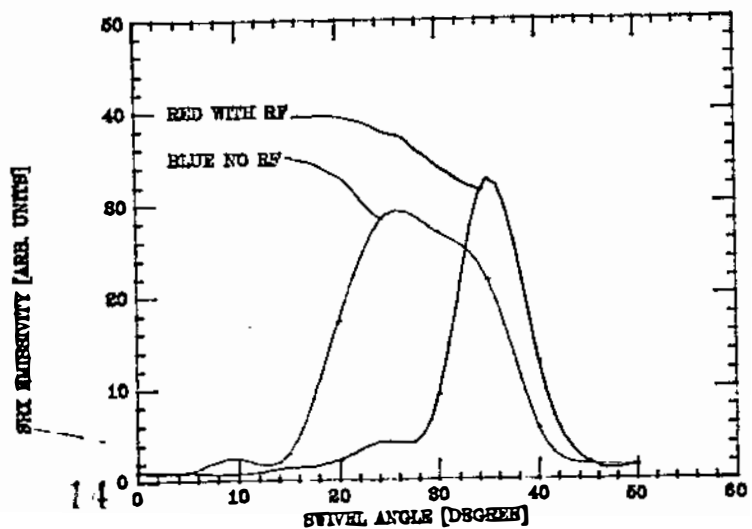

Loading peaks with antenna currents parallel to equilibrium field

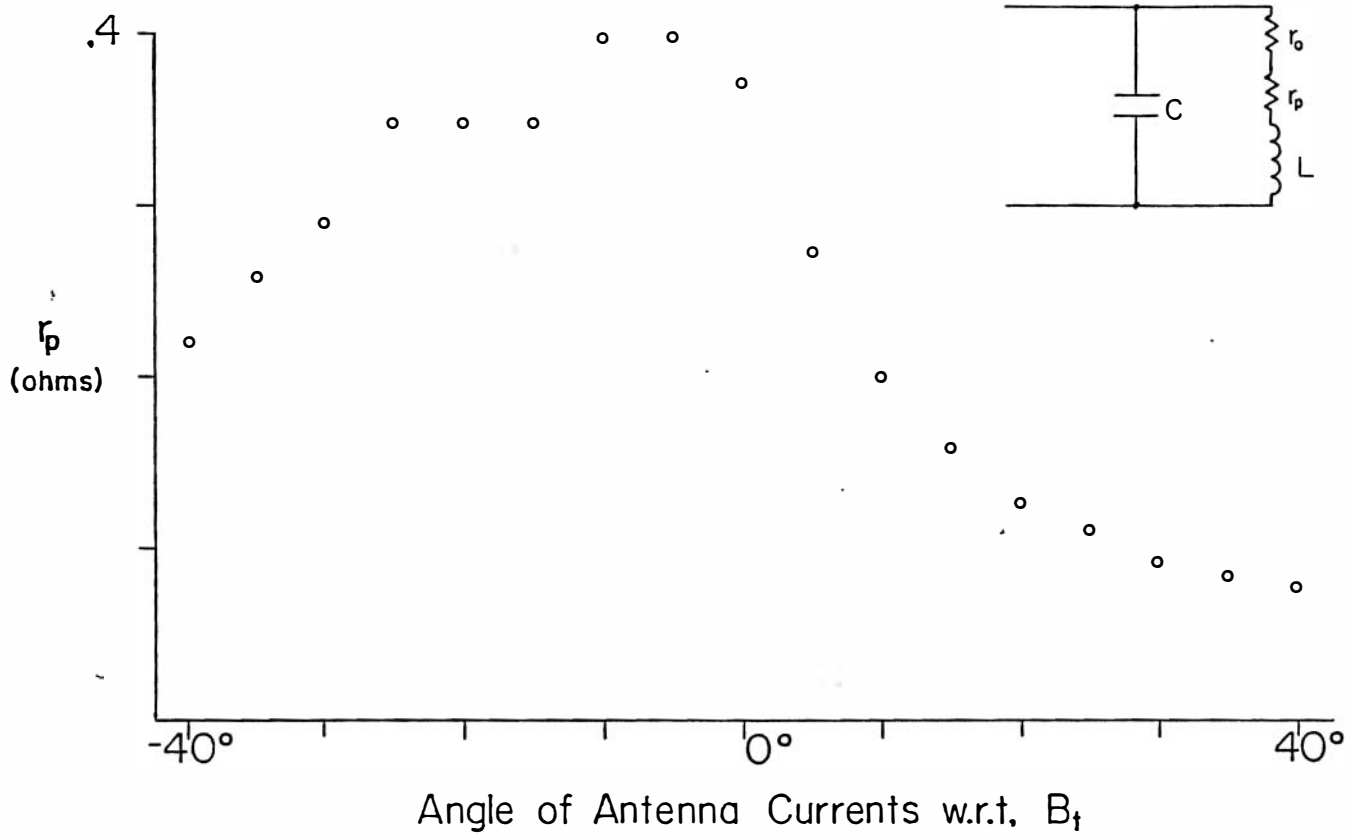

Signals are clearly polarized.

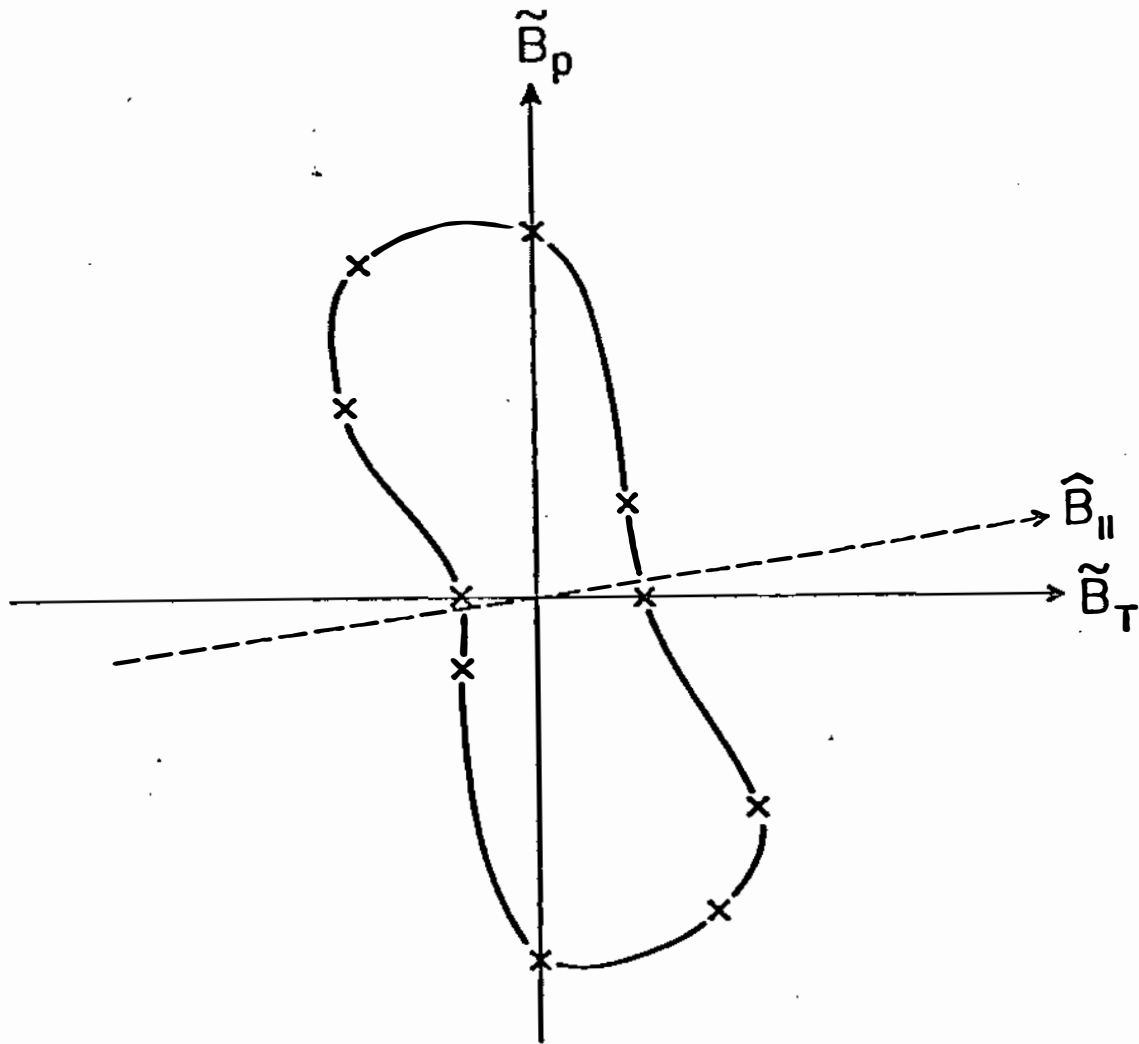

Probe signals are polarized perpendicular to the equilibrium magnetic field.

Observed signal is not a localized antenna effect.

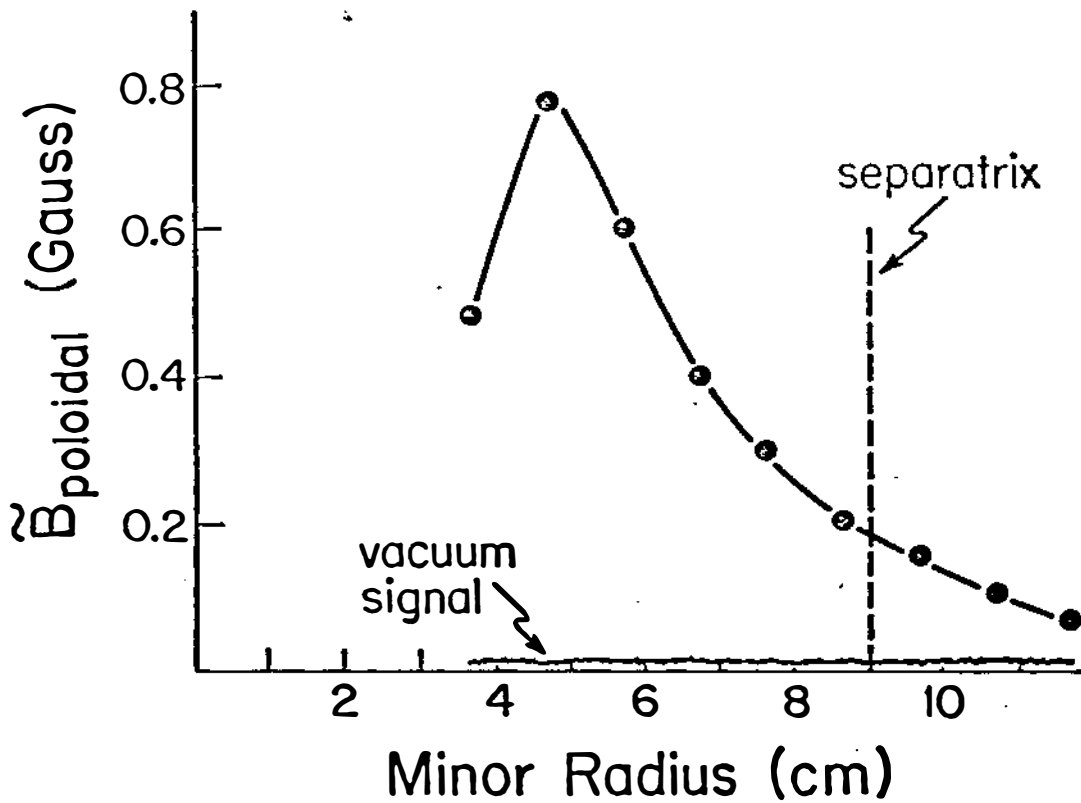

Resonance observed with a magnetic probe located 90° away toroidally from antenna.

ANTENNA LOADING AND
EDGE PROBE SIGNAL ARE
STRONGLY AFFECTED BY
SAWTOOTH ACTIVITY
WHEN ANTENNA IS FULLY
INSERTED.

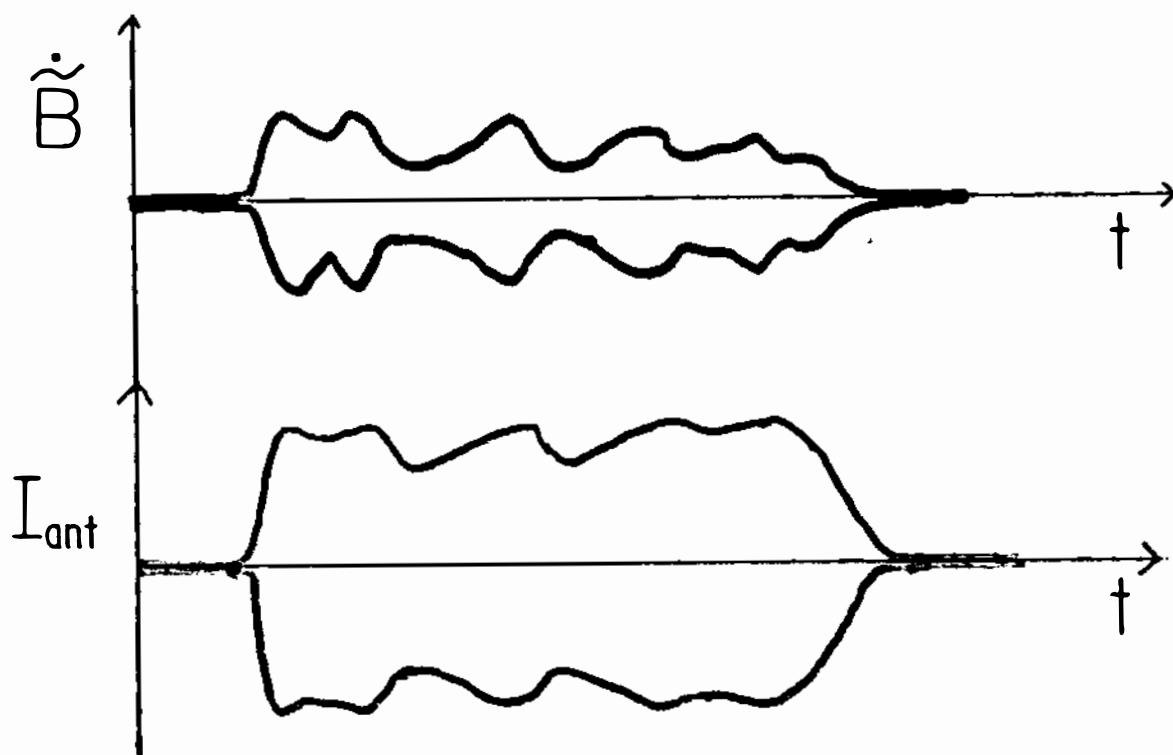

Measured probe signal does not vary strongly with antenna loading.

X - $\theta = 0^\circ$
 o - $+40^\circ$
 □ - -40°

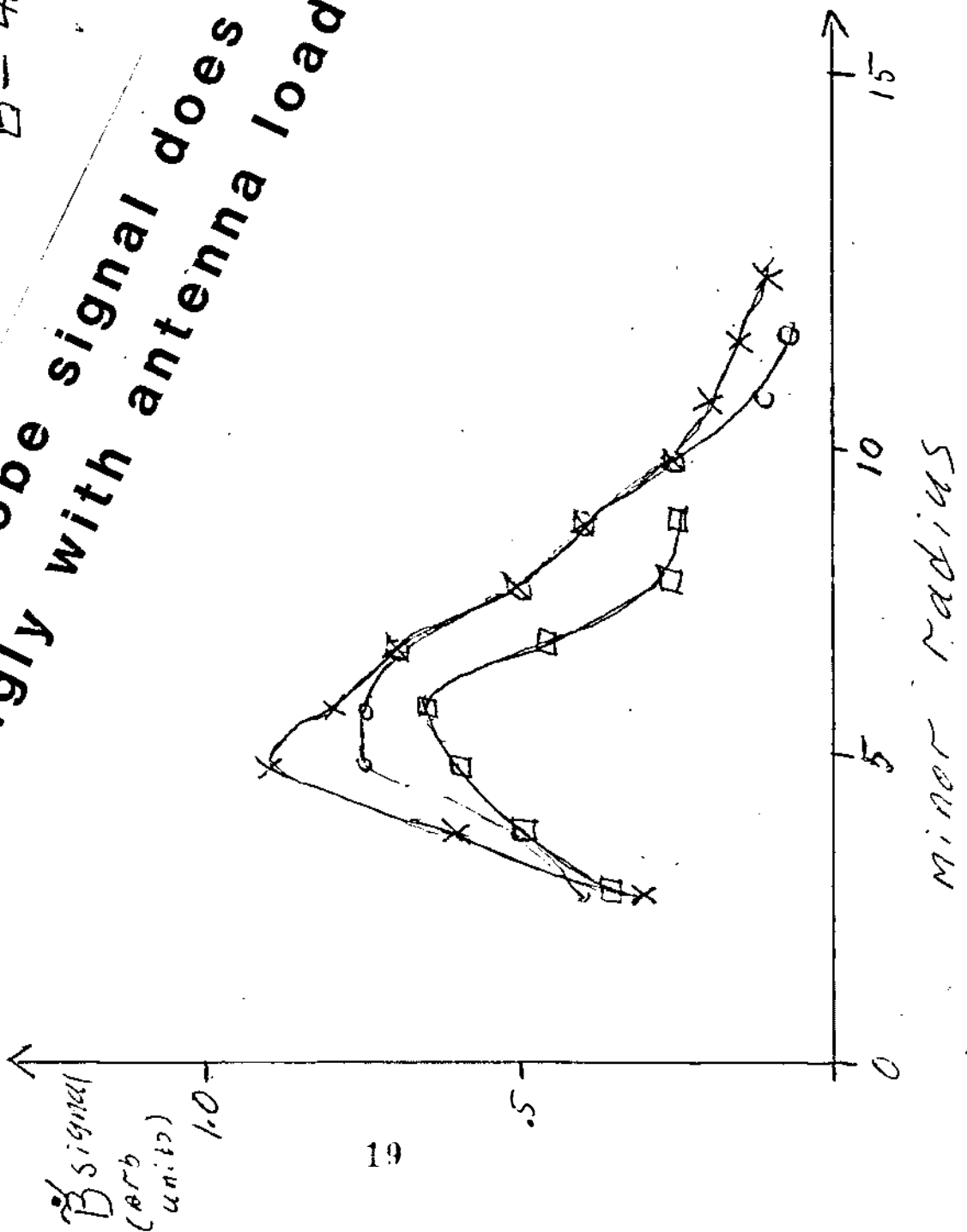

OBSERVATIONS TO DATE ARE CONSISTENT WITH THE SHEAR ALFVEN WAVE.

- 1) Probe signals are polarized perpendicular to the equilibrium magnetic field.
- 2) The spatial structure of the resonance is consistent with that expected for a shear Alfven wave i.e. the resonance is located on a flux surface and its radial position and width are consistent with theory.
- 3) Probe signals in plasma are significantly enhanced over vacuum fields.
- 4) Global modes are readily driven by a localized launching structure.

ANTENNA LOADING APPEARS TO BE AT LEAST PARTLY PARASITIC IN NATURE.

It is suspected that the component of the wave electric field which is parallel to the equilibrium magnetic field damped in a surface layer .

Loading is however small or absent when firing into the afterglow or an octupole plasma.

70 KW HAVE BEEN DELIVERED TO THE PLASMA.

SXR emissivity and edge probe signal indicate that most of this is being dissipated in surface layers and plasma in the scrape off region.